

simas<sup>®</sup>

KITCHEN



[WWW.SIMAS.IT](http://WWW.SIMAS.IT)

# simas<sup>®</sup>



*SOCIETA'  
ITALIANA  
MANUFATTI  
ARTICOLI  
SANITARI*



## LA STORIA . THE STORY

IL 12 LUGLIO 1955, NEL PIENO DEL BOOM ECONOMICO ITALIANO, IN UN MOMENTO IN CUI È FREQUENTE LA NASCITA DI AZIENDE CON CAPITALE DI LAVORO, DALLA VOLONTÀ DI 44 OPERAI VIENE FONDATA, NEL TERRITORIO DI CIVITA CASTELLANA, SIMAS: ACRONIMO DI SOCIETÀ ITALIANA MANUFATTI ARTICOLI SANITARI.

AL 1961 RISALE L'ACQUISTO DEL PRIMO FORNO A TUNNEL LUNGO 50 METRI E ALIMENTATO A GASOLIO, AL QUALE, SOLTANTO SEI ANNI PIÙ TARDI, SE NE AGGIUNGERÀ UN SECONDO LUNGO 70 METRI.

NEGLI ANNI '70 L'AZIENDA CRESCE STRUTTURALMENTE CON L'INSTALLAZIONE DI CATENE DI TRASPORTO AEREE ED ESSICCAMENTO PER BEN 7 KM, E CON L'ARRIVO DELL'ATTUALE FORNO A TUNNEL LUNGO 110 METRI. IL PROCESSO DI MECCANIZZAZIONE DEI REPARTI, QUELLO DI COLAGGIO AVVENUTO CON L'INSTALLAZIONE DI MACCHINE A BASSA PRESSIONE, E QUELLO DI VERNICIATURA CON I ROBOT DI SPRUZZO, INIZIATO NEI PRIMI

ANNI OTTANTA, VERRÀ PORTATO A COMPIMENTO NEL DECENNIO SUCCESSIVO.

NEL 2004 CAMBIA LA RAGIONE SOCIALE DELL'AZIENDA: DA SOCIETÀ A RESPONSABILITÀ LIMITATA A SOCIETÀ PER AZIONI CON 70 SOCI, 125 DIPENDENTI, 250 MILA PEZZI PRODOTTI ALL'ANNO E CON UNA RETE COMMERCIALE CHE COPRE L'INTERO TERRITORIO NAZIONALE.

E' DEL 2005 IL PROGETTO DI RESTYLING DELLA SEDE STORICA DI CIVITA CASTELLANA, CHE VIENE INAUGURATA IL 12 LUGLIO IN ONORE DEI 50 ANNI DI VITA DELL'AZIENDA. PER QUESTA RICORRENZA SIMAS APRE ANCHE UNO SPAZIO A MILANO, CON L'INTENTO DI DAR VITA A UN LUOGO DI INCONTRI E LAVORO PER ARCHITETTI E PROGETTISTI.

JULY 12, 1955 SIMAS IS FOUNDED, IN THE MIDST OF THE ITALIAN ECONOMIC BOOM, THANKS TO THE EFFORTS OF 44 WORKERS, THE FOUNDATION OF COMPANIES BASED ON HUMAN CAPITAL BEING QUITE COMMON AT THE AGE. IN 1961 THE FIRST TUNNEL KILN IS BOUGHT, 50 M LONG, GAS OIL FUELED AND A SECOND ONE, 70 M LONG WILL FOLLOW 6 YEARS LATER. ALL ALONG THE 70S, THE COMPANY UNDERGOES A HUGE STRUCTURAL GROWTH THANKS TO THE INSTALLATION OF SUSPENDED CHAINS FOR THE TRANSPORTATION AND DRYING OF THE PRODUCTS, RUNNING ALL ACROSS THE SPACES OF THE FACTORY, FOR A LENGTH OF 7 KM AND THANKS TO A NEW TUNNEL KILN 110 M LONG. THE AUTOMATION OF THE PRODUCTION DEPARTMENTS, STARTED IN THE EARLY 80S WILL BE COMPLETED IN THE FOLLOWING DECADES WITH THE INSTALLATION OF HIGH-PRESSURE MOLDING MACHINES AND ROBOTIC ENAMEL-PAINTING DEVICES. IN 2004 THE COMPANY CHANGES FROM LIMITED LIABILITY ASSET TO A STOCK HOLDING ONE WITH 70 MEMBERS, 125 WORKERS, 250 THOUSAND PIECES MANUFACTURED PER YEAR AND A SALES NETWORK COMPLETELY COVERING THE NATIONAL TERRITORY. JULY 12, 2005 THE COMPANY CELEBRATES ITS 50TH ANNIVERSARY WITH A COMPLETE RESTYLING OF THE HISTORICAL SITE IN CIVITA CASTELLANA. ON THIS SAME OCCASION SIMAS INAUGURATES A SPACE IN MILAN TO BECOME A SITE FOR MEETING AND EVENTS FOR ARCHITECTS AND DESIGNERS.



## HAND-MADE IN ITALY

IN SIMAS TUTTO È RIGOROSAMENTE MADE IN ITALY , PER UN PRODOTTO LA CUI REALIZZAZIONE HA NELLE FASI DI COLAGGIO, VERNICIATURA E COTTURA NEI FORNI A TUNNEL, I MOMENTI SALIENTI DI UN PROCESSO ANCORA OGGI INTERAMENTE SVOLTO ALL'INTERNO DELL'AZIENDA. EMBLEMA DELL'ARTIGIANALITÀ, INSITA NEL DNA DI MOLTE AZIENDE ITALIANE, SIMAS NEL RISPETTO DELLA TRADIZIONE CONTINUA A PUNTARE SU QUEI VALORI DAI QUALI È NATA: LA CONDIVISIONE DELLE IDEE , IL LAVORO DI SQUADRA NEL REALIZZARLE E UNA PUNTUALE ASSISTENZA VERSO I CLIENTI.

IN SIMAS EVERYTHING IS STRICTLY MADE IN ITALY, EVERY STEP OF PRODUCTION FROM MOLDING TO ENAMEL-PAINTING TO COOKING IN THE TUNNEL KILN BEING DONE INSIDE THE FACTORY. A SYMBOL OF THAT CRAFTSMANSHIP ENCLOSED IN THE DNA OF MANY ITALIAN COMPANIES AND RESPECTFUL OF ITS TRADITIONS SIMAS CONTINUES TO FOCUS ON VALUES SUCH AS IDEAS SHARING, TEAMWORK AND PUNCTUAL CUSTOMER CARE.





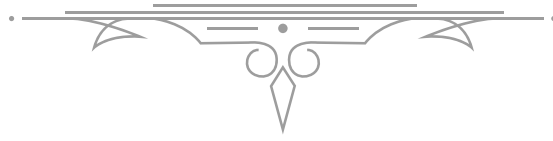

Q500



LAVELLO DA CUCINA REVERSIBILE 75 CM  
REVERSIBLE 30" SINGLE BOWL FIRECLAY FARMHOUSE SINK

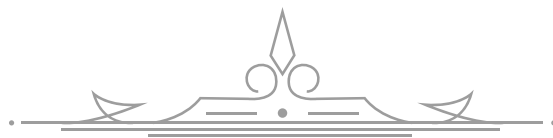

## OPZIONI COLORE . COLOR OPTIONS



**01**  
BIANCO LUCIDO  
GLOSSY WHITE



**26**  
NERO LUCIDO  
GLOSSY BLACK



**42**  
BIANCO OPACO  
MATT WHITE



**65**  
NERO OPACO  
MATT BLACK



**40**  
BLU COBALTO  
GLOSSY DEEP BLUE



**38**  
PERGAMON LUCIDO  
GLOSSY BISCUIT



## INSTALLAZIONE . INSTALLATION

REVERSIBLE  ELBISREVER





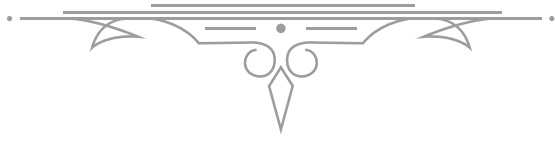

# Q500

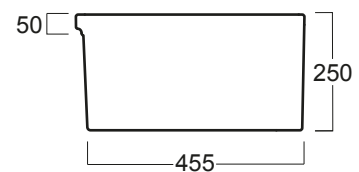
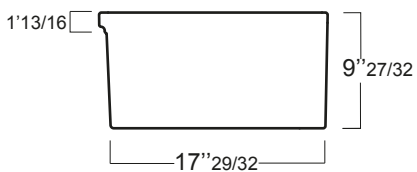
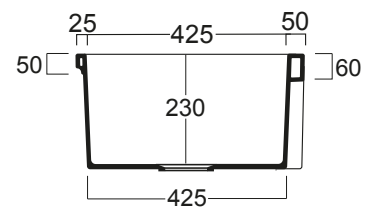
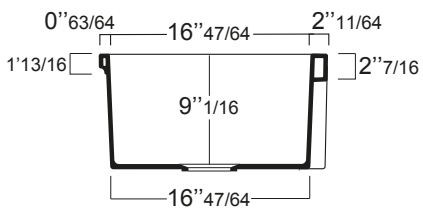
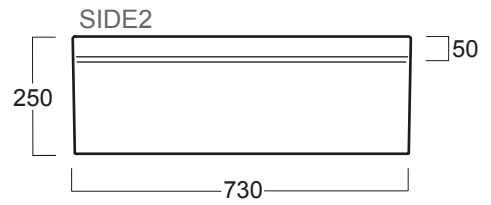
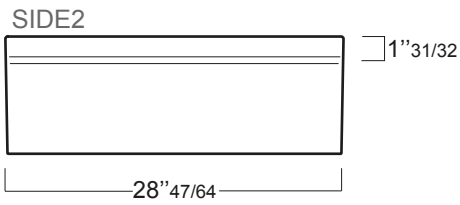
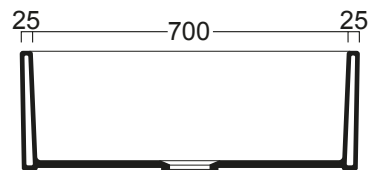
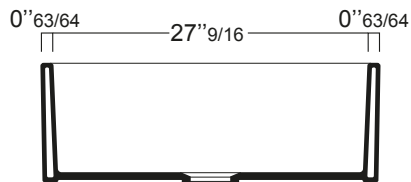
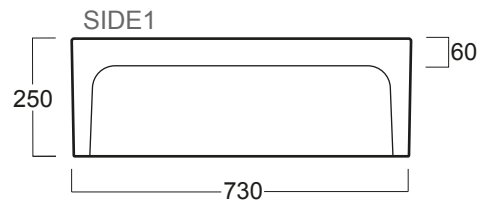
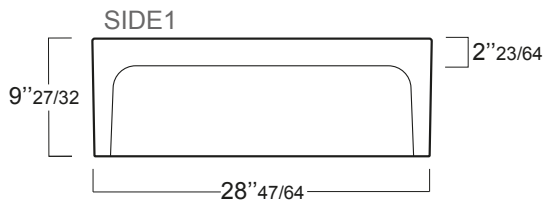
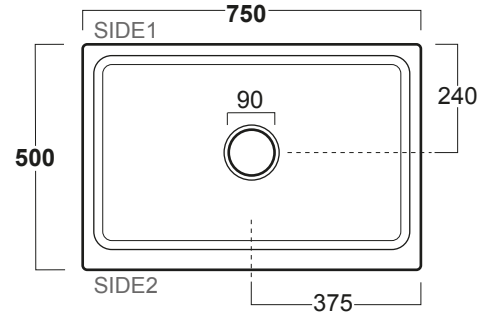
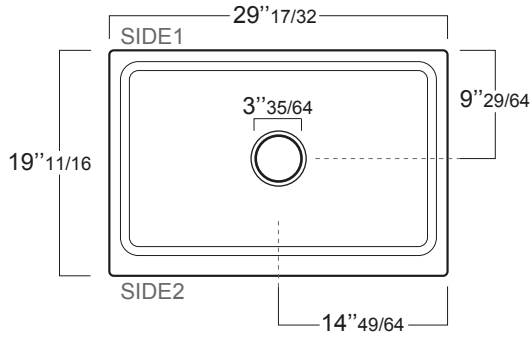





Q536



LAVELLO DA CUCINA REVERSIBILE 90 CM  
REVERSIBLE 36" BOWL FIRECLAY FARMHOUSE SINK

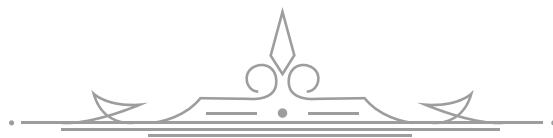

## OPZIONI COLORE . COLOR OPTIONS



**01**  
BIANCO LUCIDO  
GLOSSY WHITE



**26**  
NERO LUCIDO  
GLOSSY BLACK



**42**  
BIANCO OPACO  
MATT WHITE



**65**  
NERO OPACO  
MATT BLACK



**40**  
BLU COBALTO  
GLOSSY DEEP BLUE



**38**  
PERGAMON LUCIDO  
GLOSSY BISCUIT



## INSTALLAZIONE . INSTALLATION

REVERSIBLE



ELBISREVER





# Q536

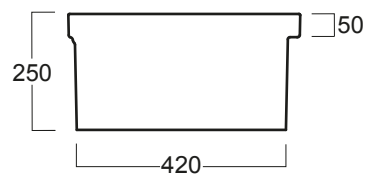
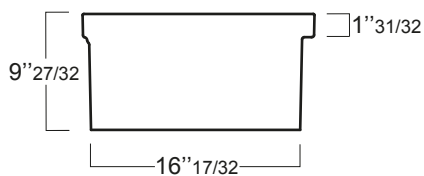
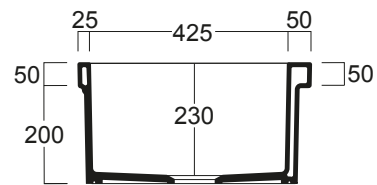
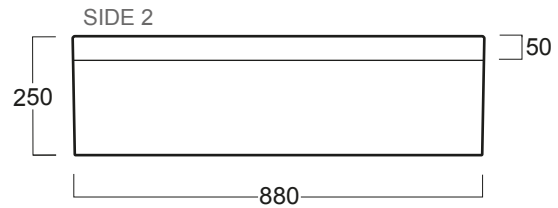
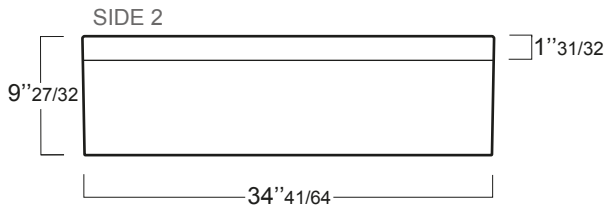
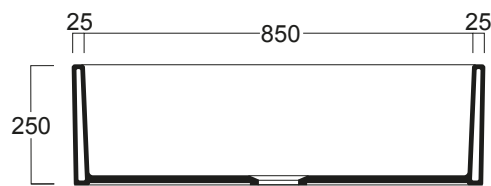
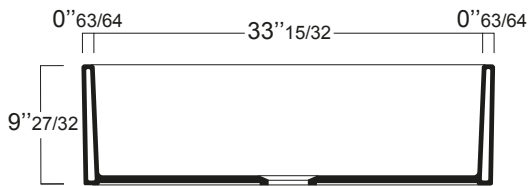
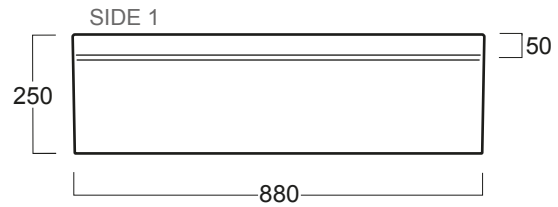
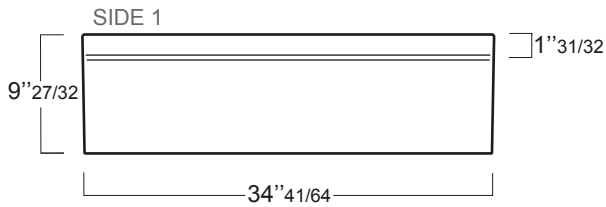
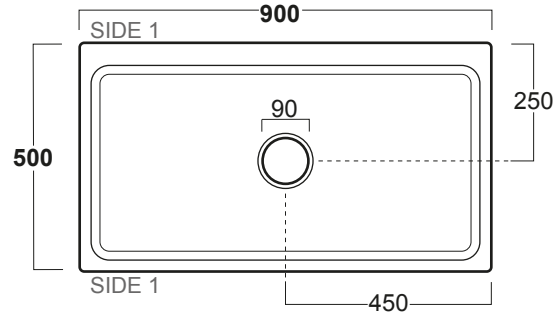
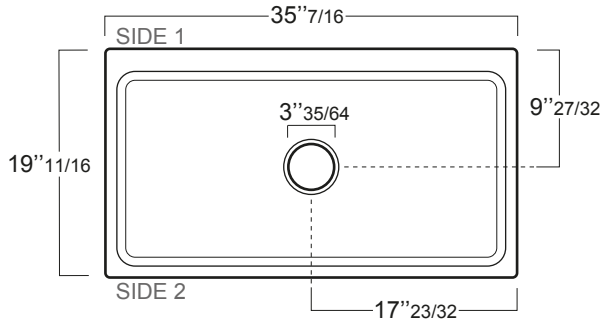



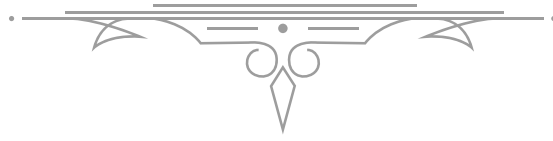

Q540



LAVELLO DA CUCINA REVERSIBILE 90 CM  
CON PIANO LATERALE  
REVERSIBLE 36" BOWL WITH DRYING RACK  
FIRECLAY FARMHOUSE SINK

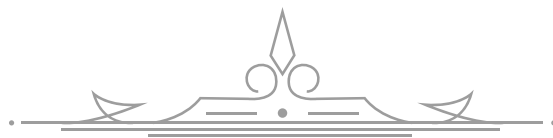

## OPZIONI COLORE . COLOR OPTIONS



**01**  
BIANCO LUCIDO  
GLOSSY WHITE



**26**  
NERO LUCIDO  
GLOSSY BLACK



**42**  
BIANCO OPACO  
MATT WHITE



**65**  
NERO OPACO  
MATT BLACK



**40**  
BLU COBALTO  
GLOSSY DEEP BLUE



**38**  
PERGAMON LUCIDO  
GLOSSY BISCUIT



## INSTALLAZIONE . INSTALLATION

REVERSIBLE  ELBISREVER





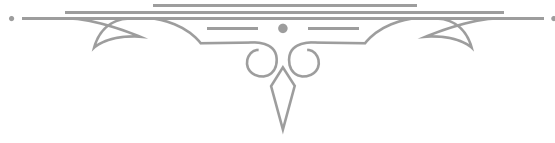

# Q540

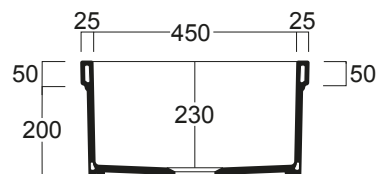
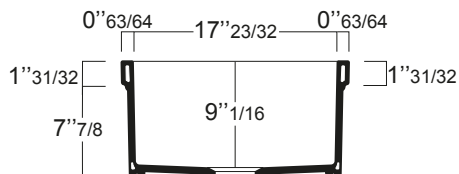
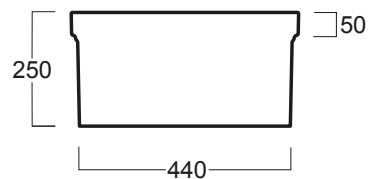
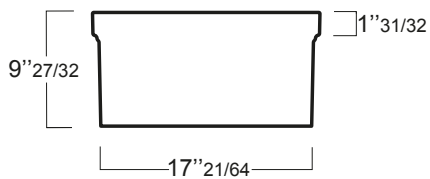
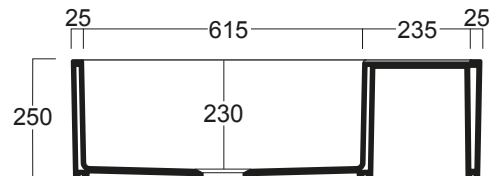
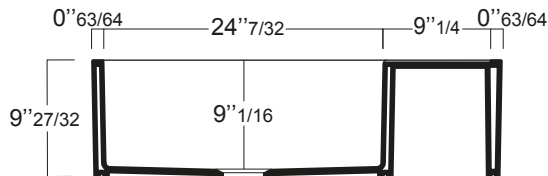
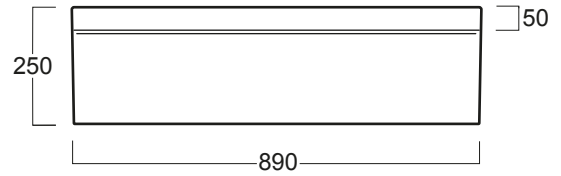
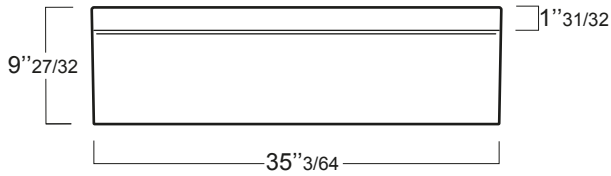
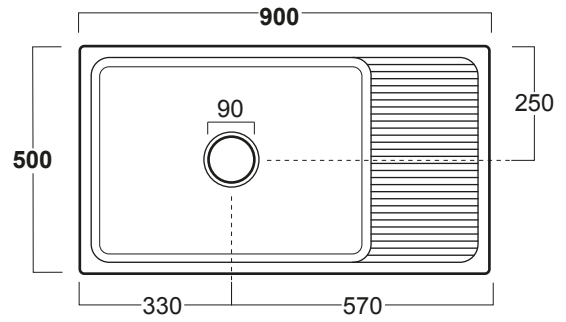
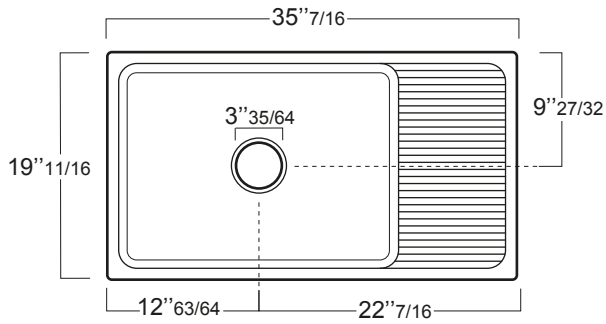





Q532



LAVELLO DA CUCINA DOPPIA VASCA 83 CM  
33" DOUBLE BOWL FIRECLAY FARMHOUSE SINK





## OPZIONI COLORE . COLOR OPTIONS



**01**  
BIANCO LUCIDO  
GLOSSY WHITE



**26**  
NERO LUCIDO  
GLOSSY BLACK



**42**  
BIANCO OPACO  
MATT WHITE



**65**  
NERO OPACO  
MATT BLACK



**40**  
BLU COBALTO  
GLOSSY DEEP BLUE



**38**  
PERGAMON LUCIDO  
GLOSSY BISCUIT



## INSTALLAZIONE . INSTALLATION





# Q532

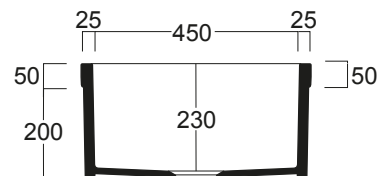
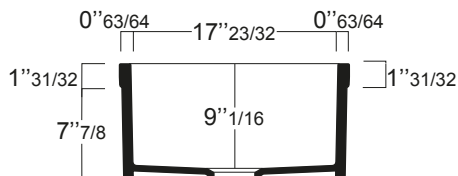
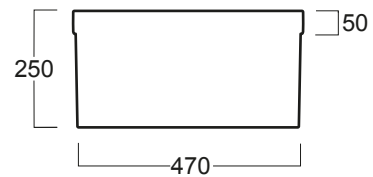
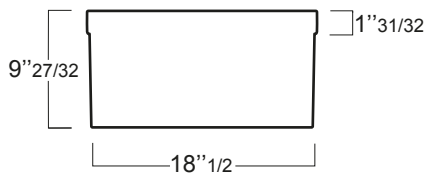
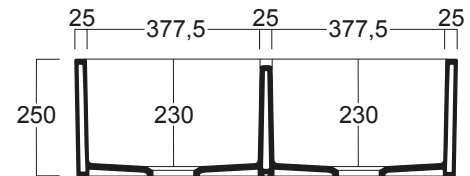
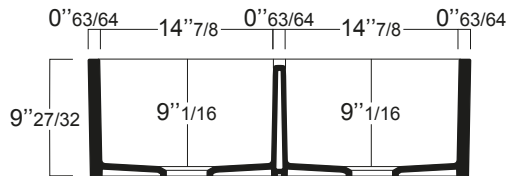
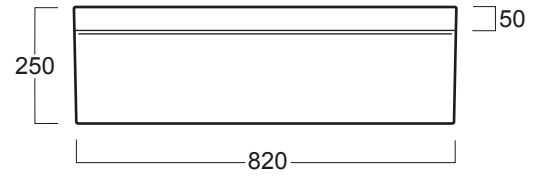
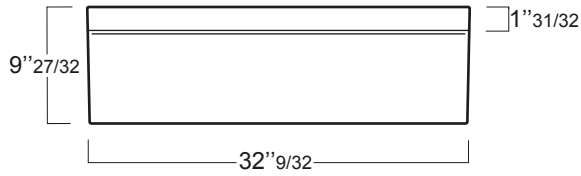
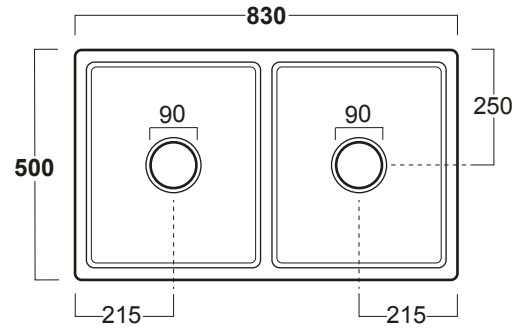
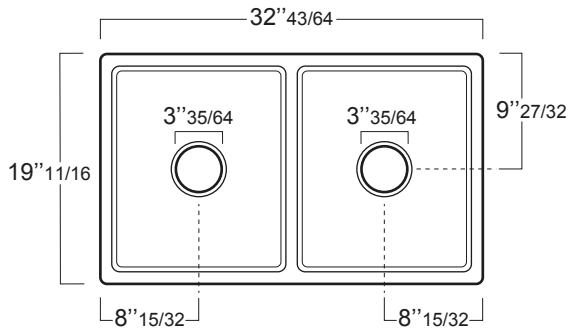

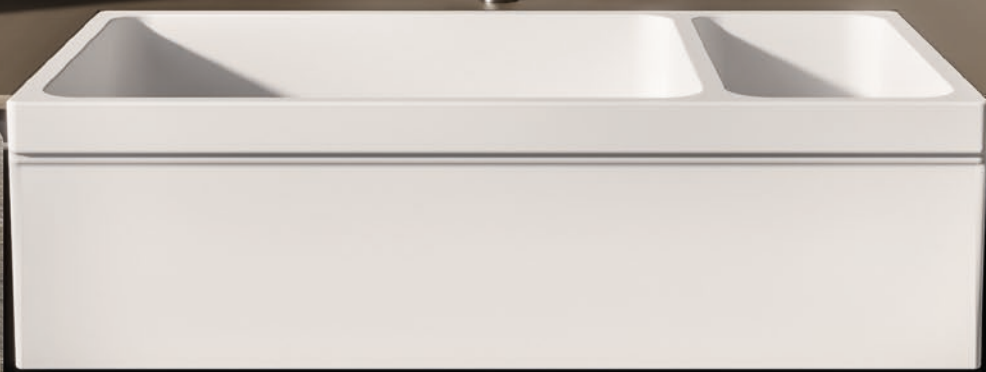

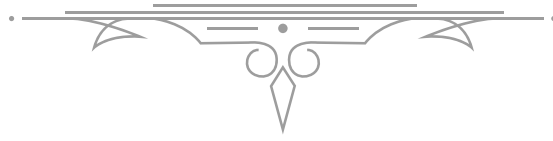

Q542



LAVELLO DA CUCINA REVERSIBILE 90 CM  
REVERSIBLE 36" 1 ½ BOWL FIRECLAY SINK

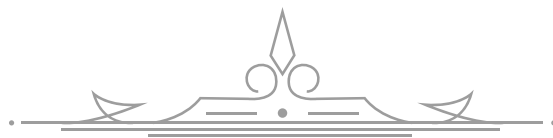

## OPZIONI COLORE . COLOR OPTIONS



**01**  
BIANCO LUCIDO  
GLOSSY WHITE



**26**  
NERO LUCIDO  
GLOSSY BLACK



**42**  
BIANCO OPACO  
MATT WHITE



**65**  
NERO OPACO  
MATT BLACK



**40**  
BLU COBALTO  
GLOSSY DEEP BLUE



**38**  
PERGAMON LUCIDO  
GLOSSY BISCUIT



## INSTALLAZIONE . INSTALLATION

REVERSIBLE



ELBISREVER







# Q542

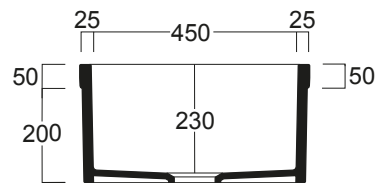
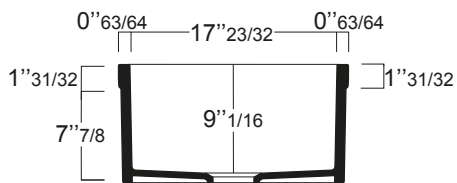
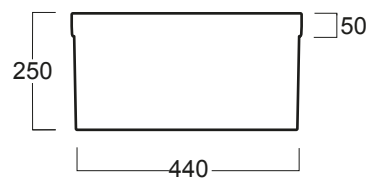
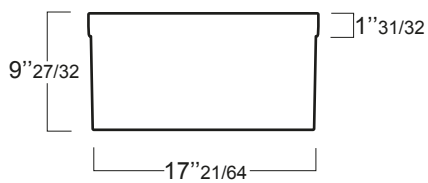
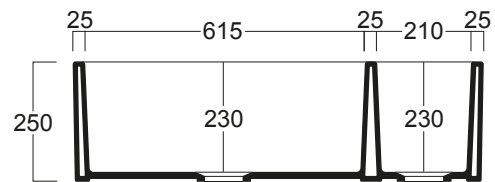
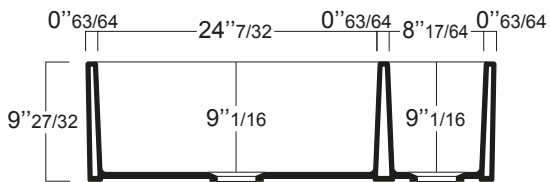
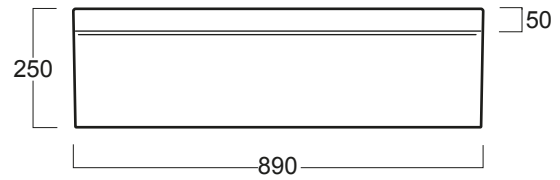
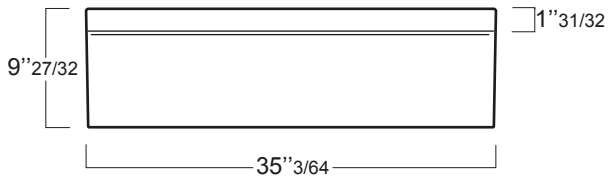
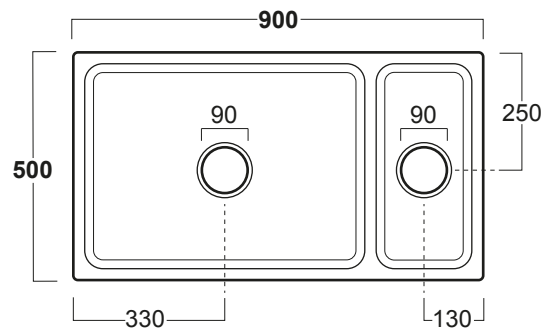
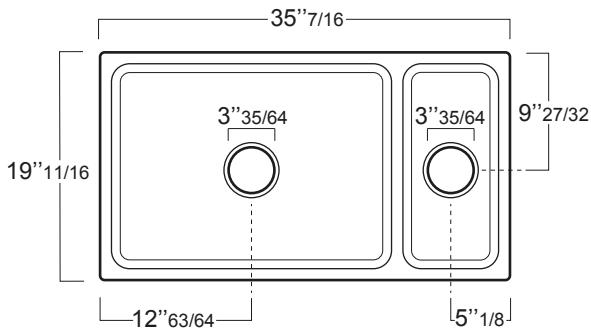





Q600



LAVELLO DA CUCINA PER INSTALLAZIONE  
INCASSO/SOPRAPIANO 84 CM  
RECESSED/COUNTERTOP 33" BOWL  
FIRECLAY FARMHOUSE SINK



## OPZIONI COLORE . COLOR OPTIONS



**01**  
BIANCO LUCIDO  
GLOSSY WHITE



**26**  
NERO LUCIDO  
GLOSSY BLACK



**42**  
BIANCO OPACO  
MATT WHITE



**65**  
NERO OPACO  
MATT BLACK



**40**  
BLU COBALTO  
GLOSSY DEEP BLUE



**38**  
PERGAMON LUCIDO  
GLOSSY BISCUIT



## INSTALLAZIONE . INSTALLATION

INCASSO/APPOGGIO



RECESSED/COUNTERTOP



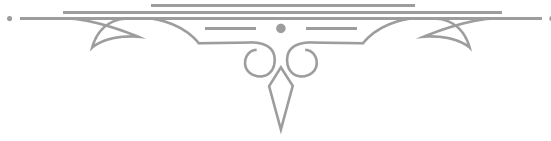

# Q600

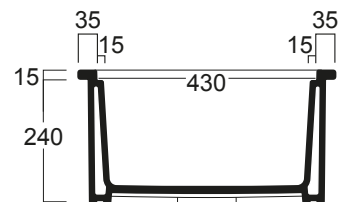
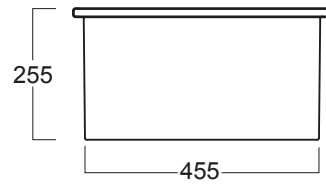
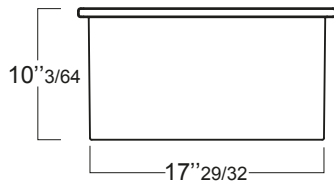
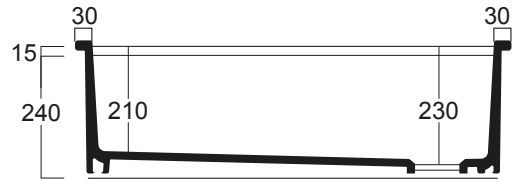
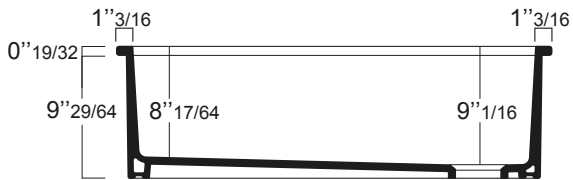
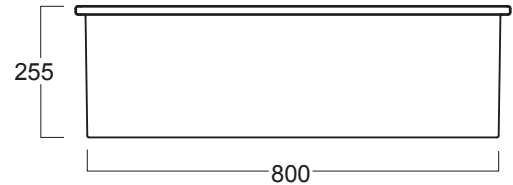
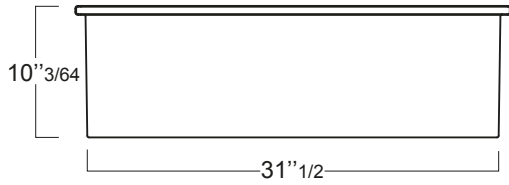
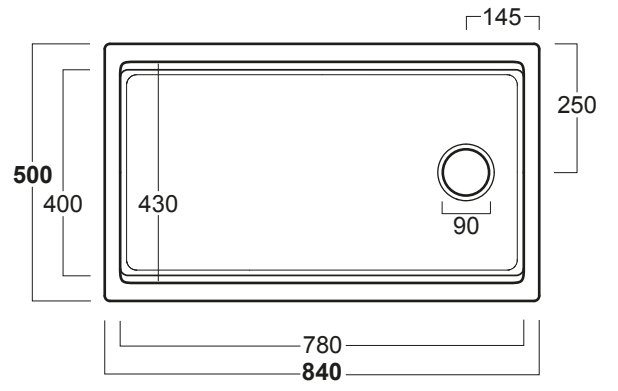
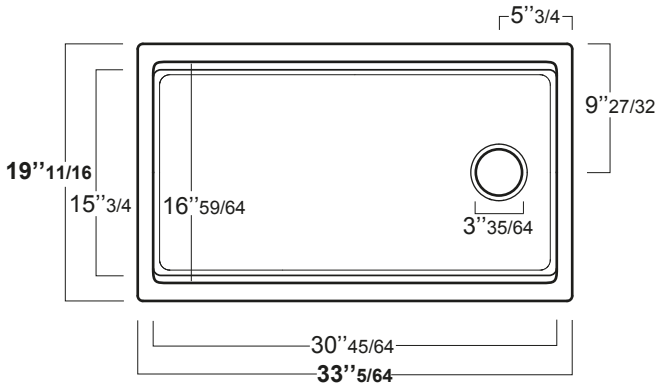



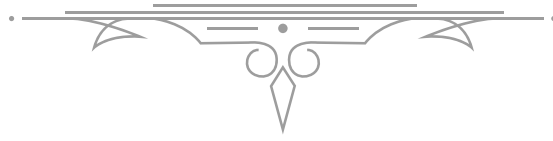

Q700



LAVELLO ROTONDO PER INSTALLAZIONE INCASSO 45CM  
RECESSED ROUNDED 17" 1/2 FIRECLAY SINK



## OPZIONI COLORE . COLOR OPTIONS



**01**  
BIANCO LUCIDO  
GLOSSY WHITE



**26**  
NERO LUCIDO  
GLOSSY BLACK



**42**  
BIANCO OPACO  
MATT WHITE



**65**  
NERO OPACO  
MATT BLACK



**40**  
BLU COBALTO  
GLOSSY DEEP BLUE



**38**  
PERGAMON LUCIDO  
GLOSSY BISCUIT



## INSTALLAZIONE . INSTALLATION

### INCASSO . RECESSED







# Q700

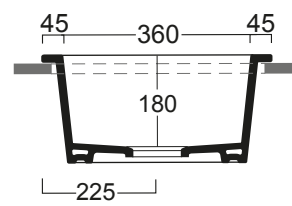
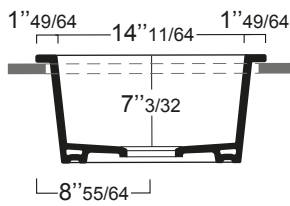
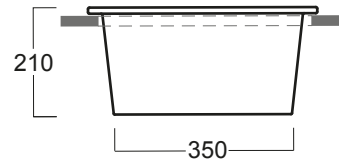
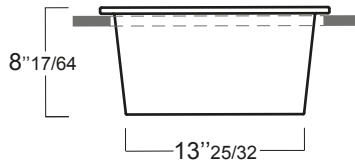
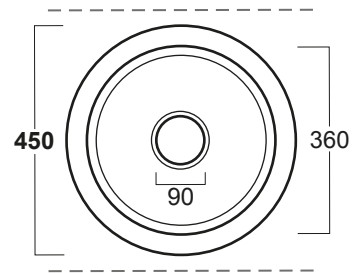
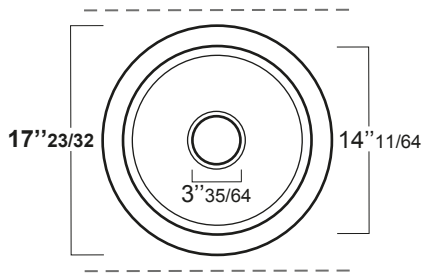

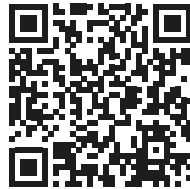
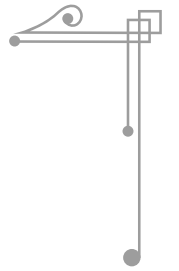
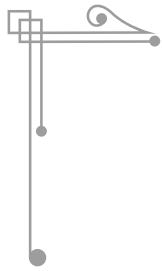

*SIMAS spa*  
*via Falerina km 3*  
*01033 Civita Castellana*  
*(Viterbo)*  
*Italy*  
*www.simas.it*



[WWW.SIMAS.IT](http://WWW.SIMAS.IT)